

VDD33

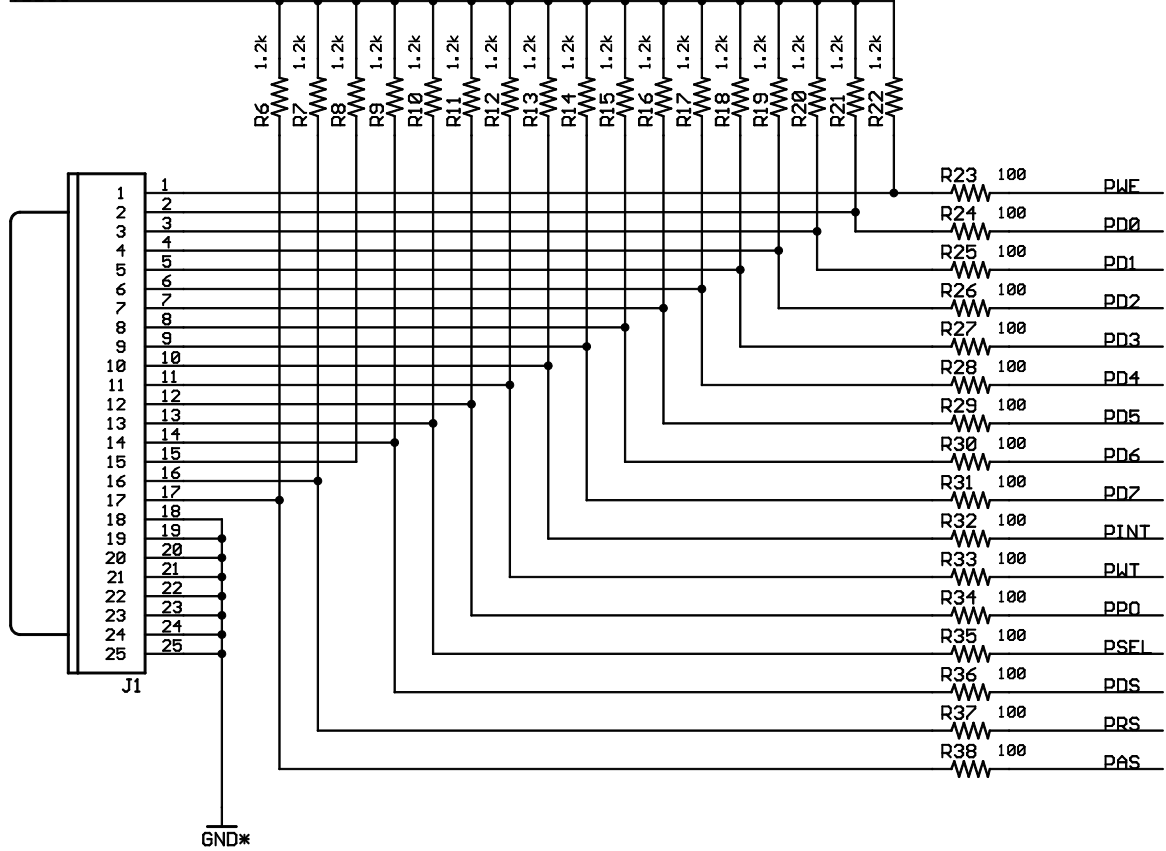

Parallel Port Test Point

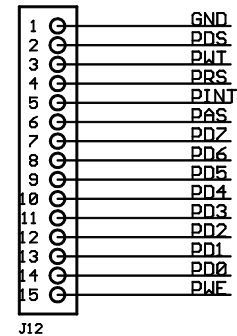

D2, FPGA Development Base Board Copyright 2004, Digilent Inc.	
TITLE: D1abD2	
Document Number: PB-500-004	REV: C
Date: 4/15/2004 11:22:57a	Sheet: 1/5

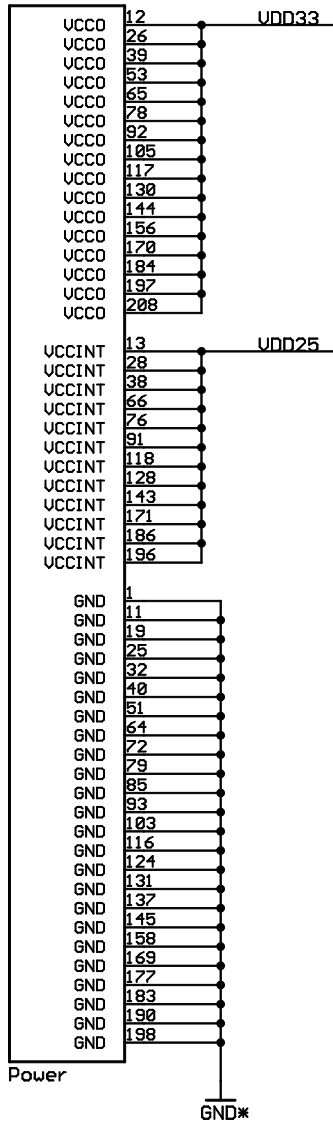

TMS	2	TMS
TDI	159	TDI
TDO	157	TD0
TCK	207	TCK
GCK0	80	CLK1
GCK1	77	RTN1
GCK2	182	B12
GCK3	185	B11
M0	52	MODE0
M1	50	MODE1
M2	54	MODE2
/PROGRAM	106	PR0G
DONE	104	DONE
CCLK	155	CCLK
IO/INIT	107	INIT
IO/DOUT	154	C22
IO/DIN/D0	153	DIN
IO/D1	146	C29
IO/D2	142	C30
IO/D3	135	C36
IO/D4	126	D6
IO/D5	119	D12
IO/D6	115	D11
IO/D7	108	D20
IO/CS	160	C21
IO/WRITE	161	C20
N/C	55	
N/C	56	

Special Function

XC2S200-PQ208
IC1

I0001	3	PWT
I0002	4	PINT
I0003	5	PD7
I0004	6	PD6
I0005	7	PD5
I0006	8	PD4
I0007	9	PD3
I0008	10	PD2
I0009	14	PD1
I0010	15	PD0
I0011	16	A40
I0012	17	A39
I0013	18	A38
I0014	20	A37
I0015	21	A36
I0016	22	A35
I0017	23	A34
I0018	24	A33
I0019	27	A32
I0020	29	A31
I0021	30	A30
I0022	31	A29
I0023	33	A28
I0024	34	A27
I0025	35	A26
I0026	36	A25
I0027	37	A24
I0028	41	A23
I0029	42	A22
I0030	43	A21
I0031	44	A20
I0032	45	A19
I0033	46	A18
I0034	47	A17
I0035	48	A16
I0036	49	A15
I0037	57	A14
I0038	58	A13
I0039	59	A12
I0040	60	A11
I0041	61	A10
I0042	62	A9
I0043	63	A8
I0044	67	A7
I0045	68	A6
I0046	69	A5
I0047	70	A4
I0048	71	LED1

General I/O

I0049	73	D39
I0050	74	D40
I0051	75	D37
I0052	81	D38
I0053	82	D35
I0054	83	D36
I0055	84	D33
I0056	86	D34
I0057	87	D31
I0058	88	D32
I0059	89	D29
I0060	90	D30
I0061	94	D27
I0062	95	D28
I0063	96	D25
I0064	97	D26
I0065	98	D23
I0066	99	D24
I0067	100	D21
I0068	101	D22
I0069	102	D19
I0070	109	D17
I0071	110	D18
I0072	111	D15
I0073	112	D16
I0074	113	D13
I0075	114	D14
I0076	120	D9
I0077	121	D10
I0078	122	D7
I0079	123	D8
I0080	125	D5
I0081	127	D4
I0082	129	C40
I0083	132	C39
I0084	133	C38
I0085	134	C37
I0086	136	C35
I0087	138	C34
I0088	139	C33
I0089	140	C32
I0090	141	C31
I0091	147	C28
I0092	148	C27
I0093	149	C26
I0094	150	C25
I0095	151	C24
I0096	152	C23

General I/O

I0097	162	C19
I0098	163	C18
I0099	164	C17
I0100	165	C16
I0101	166	C15
I0102	167	C14
I0103	168	C13
I0104	172	C12
I0105	173	C11
I0106	174	C10
I0107	175	C9
I0108	176	C8
I0109	178	C7
I0110	179	C6
I0111	180	C5
I0112	181	C4
I0113	187	B10
I0114	188	B9
I0115	189	B8
I0116	191	B7
I0117	192	B6
I0118	193	B5
I0119	194	B4
I0120	195	RS232_RTS_IN
I0121	199	RS232_CTS_OUT
I0122	200	RS232_DSR_OUT
I0123	201	RS232_TX_DATA
I0124	202	RS232_RX_DATA
I0125	203	PRS
I0126	204	PAS
I0127	205	PDS
I0128	206	PWF

General I/O

D2, FPGA Development Base Board Copyright 2004, Digilent Inc.	
TITLE: D1abD2	
Document Number: PB-500-004	REV: C
Date: 4/15/2004 11:22:57a	Sheet: 2/5

Connector A

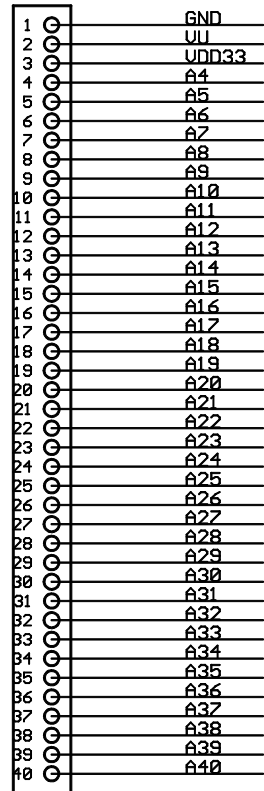

J2

Connector B

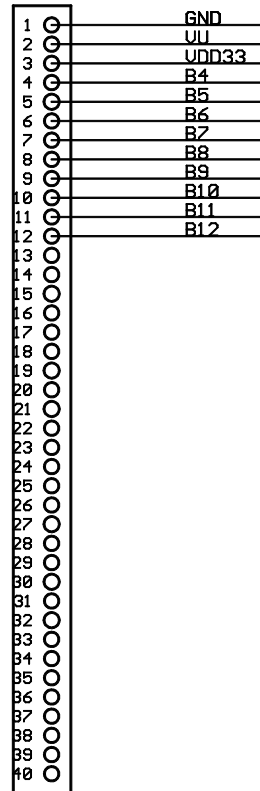

J3

Connector C

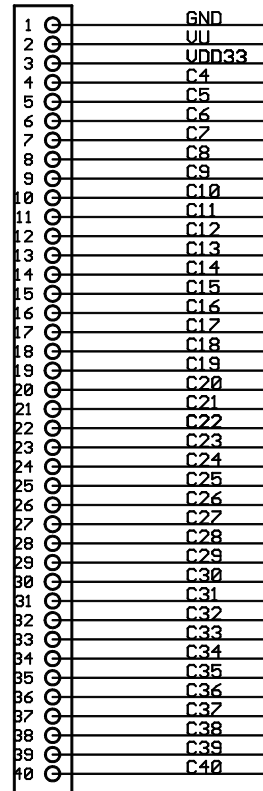

J4

Connector D

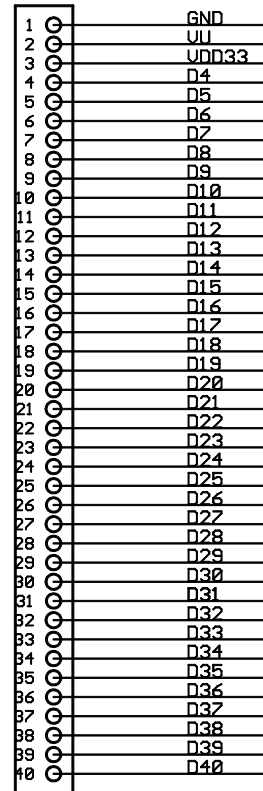

J5

Connector E

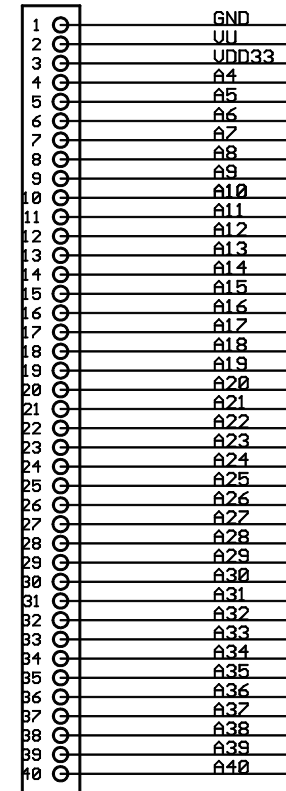

J6

Connector F

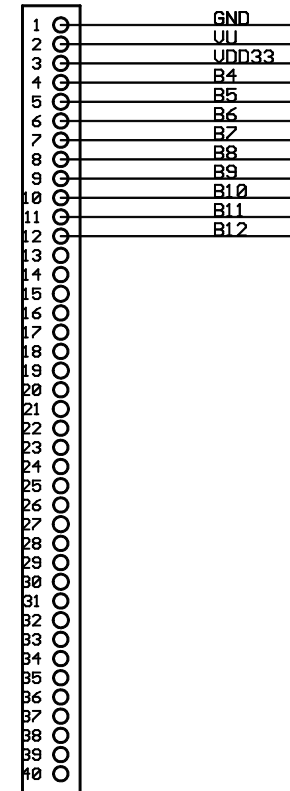

J7

JTAG Programming Connector

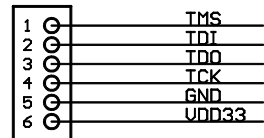

J10

Gate Array Mode Selection

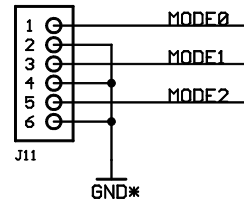

J11

D2, FPGA Development Base Board Copyright 2004, Digilent Inc.	
TITLE: D1abD2	
Document Number: PB-500-004	REV: C
Date: 4/15/2004 11:22:57a	Sheet: 3/5

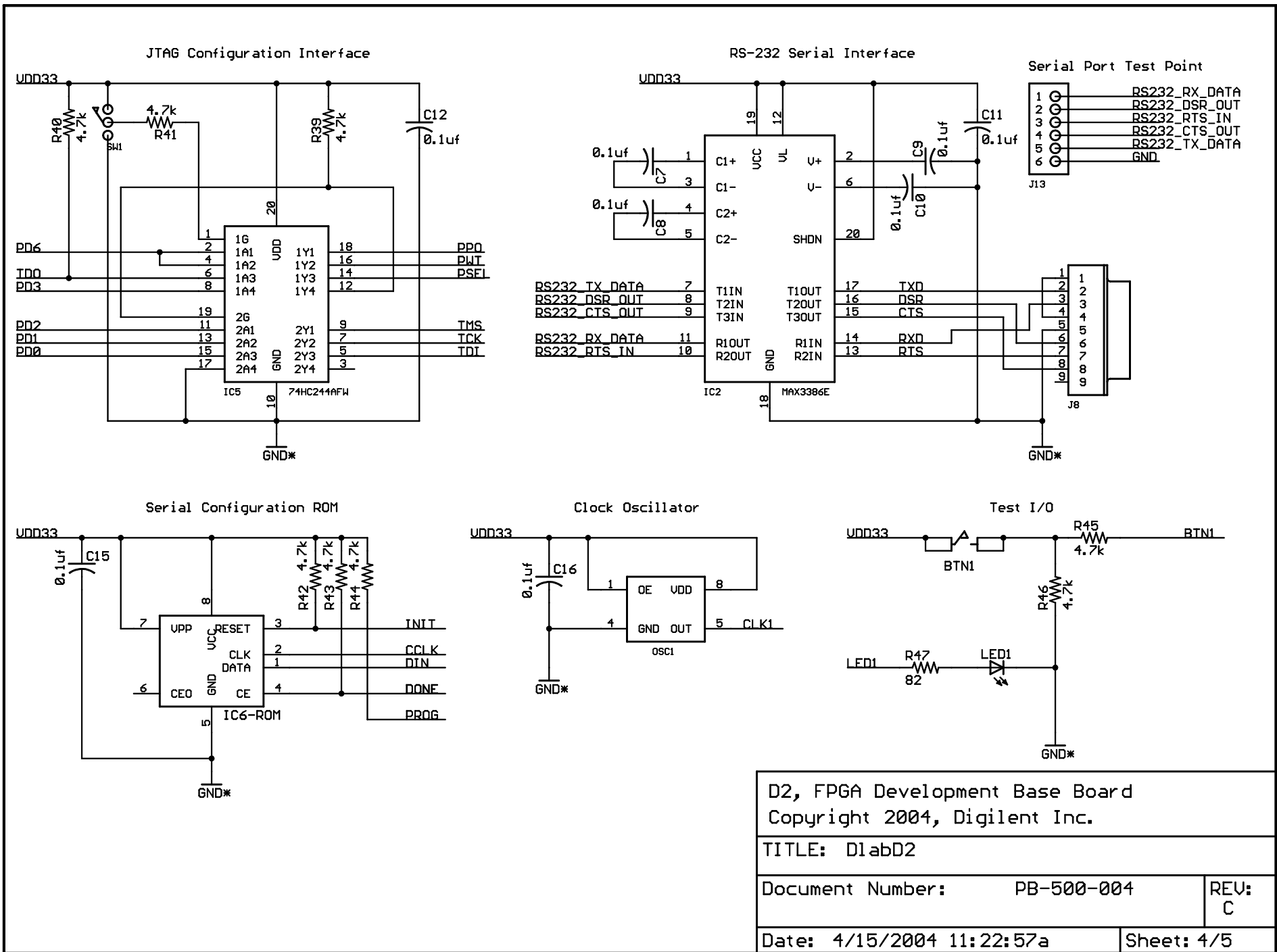

D2, FPGA Development Base Board
 Copyright 2004, Digilent Inc.

TITLE: D1abD2

Document Number: PB-500-004	REV: C
Date: 4/15/2004 11:22:57a	Sheet: 4/5

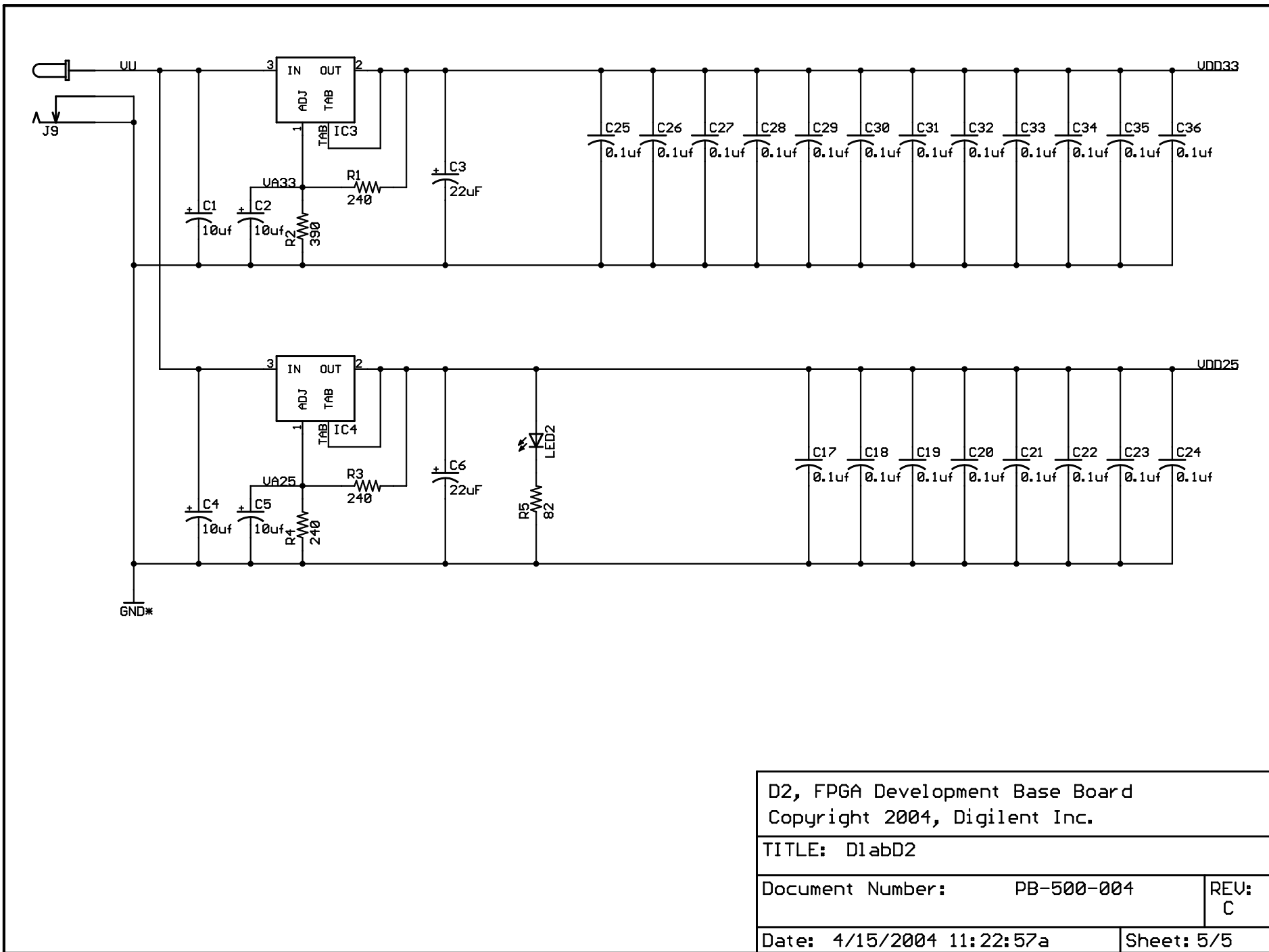

D2, FPGA Development Base Board Copyright 2004, Digilent Inc.	
TITLE: DlabD2	
Document Number: PB-500-004	REV: C
Date: 4/15/2004 11:22:57a	Sheet: 5/5